



# **GST102A/104A/108A/116A Conventional Fire Alarm Control Panel**



**Installation and Operation Manual**

*Issue 1.07 August 2012*

ERP:30308377

## CONTENTS

<b>Installation Precautions</b> .....	<b>1</b>
<b>EN 54 Information</b> .....	<b>2</b>
<b>Chapter 1 Product Overview</b> .....	<b>3</b>
1.1 Features .....	3
1.2 Technical Specifications.....	3
1.2.1 Operating Voltage .....	3
1.2.2 Batteries .....	3
1.2.3 Installation Environment.....	4
1.2.4 Load of Power Supply.....	4
1.2.5 Detection Zone .....	4
1.2.6 Output Loop .....	4
1.2.7 Remote Interface.....	5
1.3 Controls and Indications .....	5
1.3.1 Common Status Indicators.....	5
1.3.2 Zone Status Indicators .....	6
1.3.3 Operating Indicators and Keys .....	6
1.3.4 Output Indicators.....	6
1.3.5 Indicators of Control Board .....	7
1.4 Construction and Configuration .....	7
1.4.1 Appearance .....	7
1.4.2 Configuration.....	8
1.5 Terminal Description .....	9
1.5.1 Terminals on the Control Board .....	9
1.5.2 Terminals on GST116A Extension Board.....	10
1.5.3 Terminals on Signal Output Interface Board of GST116A .....	10
1.5.4 Terminals on Signal Output Interface Board of GST108A.....	11
1.5.5 Terminals on Signal Output Interface Board of GST102A/104A .....	11
1.6 Dimensions .....	11
<b>Chapter 2 Installation</b> .....	<b>12</b>
2.1 Installing the Cabinet .....	12
2.2 Mains Connection .....	12
2.3 Battery Connection .....	12
2.4 Zone Input Connection .....	13

2.4.1 Using end of line resistor .....	13
2.4.2 Using an Active End of Line Unit .....	13
2.5 Sounder/Alarm Output Connection .....	13
<b>Chapter 3 System Setup .....</b>	<b>14</b>
3.1 Setting Access Levels.....	14
3.1.1 Setting Access Level 1 .....	14
3.1.2 Setting Access Level 2 .....	14
3.1.3 Setting Access Level 3.....	14
3.2 Setting Sounder/Alarm Output.....	15
3.2.1 Example for Setting Voltage Output.....	15
3.2.2 Example for Setting Normally Open Output .....	15
3.2.3 Example for Setting Normally Closed Output .....	15
3.3 Disablement of a Zone or Output .....	15
3.3.1 Use of Disablement Function.....	15
3.3.2 Operation Steps .....	15
3.4 Setting Test Mode .....	16
3.4.1 Use of Test Mode .....	16
3.4.2 Operation Steps .....	16
3.5 Programming Output Modes .....	16
3.5.1 Setting the FACP to Default.....	17
3.5.2 Setting “With Manual Call Point” .....	17
3.5.3 Setting Associated Sounders of a Zone .....	18
3.5.4 Setting Delay Time of Alarm Output.....	19
3.6 Setting Auxiliary Functions .....	20
3.7 Ground Fault Checking and Auxiliary Power Setting .....	20
<b>Chapter 4 Operation Instructions .....</b>	<b>22</b>
4.1 Working State Description .....	22
4.1.1 State of Detection Zones.....	22
4.1.2 Alarm Output State .....	22
4.1.3 Sounder Output State .....	22
4.1.4 Safe State.....	22
4.1.5 Description of the Buzzer .....	22
4.1.6 Notes .....	23
4.2 Acknowledgement and Silence of Fault .....	23

4.3 Acknowledgement and Silence of Fire Alarm .....	23
4.4 Silencing the Sounders .....	23
4.5 Evacuation .....	23
4.6 Self-test and Reset .....	23
4.7 Setting Day/Night Mode .....	24
<b>Chapter 5 Calculation of Batteries Capacity .....</b>	<b>25</b>
<b>Chapter 6 Servicing .....</b>	<b>26</b>
6.1 Replacing the Batteries .....	26
6.2 Replacing the Fuses .....	26
6.2.1 Cautions .....	26
6.3 Troubleshooter .....	26
<b>Appendix 1 Wiring Diagram for GST116A FACP .....</b>	<b>27</b>
<b>Appendix 2 Wiring Diagram for GST108A FACP .....</b>	<b>28</b>
<b>Appendix 3 Wiring Diagram for GST104A FACP .....</b>	<b>29</b>
<b>Appendix 4 Wiring Diagram for GST102A FACP .....</b>	<b>30</b>
<b>Appendix 5 Appearance of GST116A FACP .....</b>	<b>31</b>
<b>Appendix 6 Appearance of GST108A FACP .....</b>	<b>31</b>
<b>Appendix 7 Appearance of GST104A FACP .....</b>	<b>32</b>
<b>Appendix 8 Appearance of GST102A FACP .....</b>	<b>32</b>

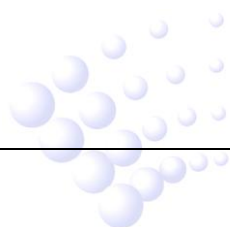

## Installation Precautions

Adherence to the following will aid in problem-free installation with long-term reliability:

- ✧ Do not attempt to install, service, or operate this unit until this manual is read and understood.
- ✧ This equipment must be installed in accordance with these instructions and the appropriate national, regional and local regulations specific to the country and location of the installation. Consult with the appropriate Authority Having Jurisdiction (AHJ) for confirmation of the requirements.
- ✧ The FACP shall only be installed and serviced by specially trained engineers.
- ✧ Disconnect all sources of power before servicing. Control unit may be damaged by removing and/or inserting cards, modules, or interconnecting cables while the unit is energized.
- ✧ Remove all electronic assemblies prior to any drilling, filing, reaming, or punching of the enclosure. When possible, make all cable entries from the sides or rear. Before making modifications, verify that they will not interfere with batteries and printed circuit board location.

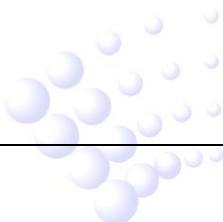

## EN 54 Information

EN 54  
✓

GST102A/104A/108A/116A Conventional Fire Alarm Control Panel (FACP) complies with the requirements of EN 54-2 1997 + A1: 2006 and EN 54-4 1997+A1: 2002+A2:2006. In addition to the basic requirements of these standards, the panel conforms to the following optional requirements.

Option		EN 54-2 Clause
Control	Delays to outputs	7.11
	Test condition	10
Outputs	Output to fire alarm devices	7.8
	Output to fire alarm routing equipment	7.9.1

EN 54  
✓

The power supply of the FACP complies with the following EN 54-4 requirements.

Power Supply Functions	EN 54-4 Clause
Power supply from the main power source	5.1
Power supply from the standby power source (batteries)	5.2
Charger	5.3
Faults	5.4

EN 54  
✓

CPD Conformity Information

 0832
Gulf Security Technology Co., Ltd. No. 80, Changjiang East Road, QETDZ, Qinhuangdao, Hebei, P. R. China 066004  11  GST102A 0832-CPD-1640 GST104A 0832-CPD-1641 GST108A 0832-CPD-1642 GST116A 0832-CPD-1643
EN 54-2 1997 + A1: 2006 EN 54-4 1997 + A1: 2002 + A2: 2006  Control and indicating equipment for fire detection and fire alarm systems for buildings  Provided Options: Delays to outputs Test condition Output to fire alarm devices Output to fire alarm routing equipment  Please refer to this manual for other technical data.

## Chapter 1 Product Overview

GST102A/104A/108A/116A Conventional Fire Alarm Control Panel is designed in compliance with EN 54-2. It's compatible with GST C-9403 Conventional Sounder Strobe designed by EN 54-3, C-9103 Conventional Rate of Rise and Fixed Temperature Heat Detector by EN 54-5, C-9102 Conventional Photoelectric Smoke Detector by EN 54-7, and DC-9204 Conventional Manual Call Point by EN 54-11. The panel is easy to install and operate. Control functions are enabled by a key switch. Programming functions are enabled by a key switch and an internal switch.

This series of panels are basically the same in application and operation, their differences are shown in Table 1-1. GST108A will be described as the example in the following sections.

Table 1-1

FACP	Number of Detection Zones	Number of Sounder Outputs
GST102A	2	2
GST104A	4	4
GST108A	8	4
GST116A	16	4

### 1.1 Features

- ◇ 2 to 16 zones can be detected, compatible with conventional detectors and manual call points. Each of the 16 detection zones can be individually configured as maximum 15 conventional detectors. The total number of detectors and manual call points in a zone shall not exceed 32.
- ◇ 4 sounder outputs, 1 alarm output and 1 fault output.
- ◇ Able to report short circuit and open circuit of detection zones, sounder outputs and alarm output.
- ◇ Designed with standby batteries and space provision for two sealed lead-acid batteries.
- ◇ Test and disable functions.
- ◇ Day/night mode settable.
- ◇ Programmable on manual call point connection, sound modes, sounder delay modes and output delay modes.
- ◇ Three access levels settable via a key switch and an internal switch.
- ◇ Reserved repeater panel interface for fire alarm indication of multiple zones.
- ◇ Providing external ports includes RESET, SILENCE, EVAC and forced Night Mode.

### 1.2 Technical Specifications

#### 1.2.1 Operating Voltage

- ◇ Input Voltage: 220V/230VAC<sup>+10%</sup><sub>-15%</sub>
- ◇ Frequency: 50/60Hz
- ◇ Input Current: 0.35 A
- ◇ Fuse: 2A delayed
- ◇ Recommended Wiring: 1.5mm<sup>2</sup> or above shield cable, complying with local installation codes.

#### 1.2.2 Batteries

- ◇ Minimum Operating Voltage: 21.5V

- ✧ Maximum Charging Current: 315mA
- ✧ Maximum Charging Voltage: 27.6V
- ✧ Battery Type: Sealed lead-acid battery
- ✧ Maximum Battery Charging Capacity: 2 batteries, 7Ah/12V.
- ✧ Recommended Battery Manufacturer and Model: Yuasa NP7-12
- ✧ Maximum internal resistance of the batteries: 1Ω
- ✧ Standby current of batteries when fully load: 0.1A
- ✧ Maximum operating current of the batteries: 2.5A
- ✧ Recommended Wiring (subject to local installation codes):
  - GST fire cable
  - Vencroft Gold and Platignum
  - Nexans NX 200 and 200 Plus (LPCB tested)
  - Prysmian FP 200 and 200 Gold
  - Draka Firetuf and Firetuf PlusAnd all LPCB approved fire cables.

### 1.2.3 Installation Environment

- ✧ Temperature: 0°C~40°C
- ✧ Relative humidity ≤95%, non-condensing.

### 1.2.4 Load of Power Supply

- ✧ The maximum output current in standby condition is 430mA (Max. a as described in Table 1 of EN 54-4 Clause 9.2.1.)
- ✧ The maximum output current in alarm condition is 2.5A (Max. b as described in Table 1 of EN 54-4 Clause 9.2.1).

### 1.2.5 Detection Zone

The FACP provides maximum 16 detection zones; each can be individually configured with maximum 15 conventional detectors.

- ✧ Loop Voltage: 15VDC~28VDC
- ✧ Standby Current: Less than 6mA (connecting with 15 conventional detectors)
- ✧ Dynamic Current: Resistance range for fire alarm is 150Ω ~1.5kΩ (normally 470Ω ), using a 4.7kΩ end of line resistor or AEOL (active end of line unit). The alarm current for a zone depends on the number of conventional devices in the zone. The alarm current for a conventional detector is about 25mA.
- ✧ Maximum output current for the 16 detection zones is 400mA.
- ✧ Recommended Wiring (subject to local installation codes):
  - GST fire cable
  - Vencroft Gold and Platignum
  - Nexans NX 200 and 200 Plus (LPCB tested)
  - Prysmian FP 200 and 200 Gold
  - Draka Firetuf and Firetuf PlusAnd all LPCB approved fire cables
- ✧ Recommended Cable Length: not longer than 1000m

### 1.2.6 Output Loop

- ✧ Recommended Wiring (subject to local installation codes):
  - GST fire cable



- Vencroft Gold and Platignum
  - Nexans NX 200 and 200 Plus (LPCB tested)
  - Prysmian FP 200 and 200 Gold
  - Draka Firetuf and Firetuf Plus
- And all LPCB approved fire cables
- ✧ Recommended Cable Length: not longer than 1000m
  - ✧ Sounder output (4 channels) and alarm output (1 channel)
    - Output Voltage: 18VDC~28VDC
    - Output Current: 300mA for each sounder output, and 300mA for fire alarm output.
    - End of Line Resistor: 4.7kΩ
  - ✧ Auxiliary Power Output
    - Output Voltage: 18VDC~28VDC
    - Output Current: 20mA normally and 500mA under fire condition.
  - ✧ Fault Output: Volt-free contact output, 1A/24VDC

### 1.2.7 Remote Interface

- ✧ Recommended Wiring (subject to local installation codes):
  - GST fire cable
  - Vencroft Gold and Platignum
  - Nexans NX 200 and 200 Plus (LPCB tested)
  - Prysmian FP 200 and 200 Gold
  - Draka Firetuf and Firetuf Plus

And all LPCB approved Fire cables

- ✧ Recommended Cable Length: not longer than 1000m
- ✧ Day mode input, remote EVAC input, remote SILENCE input and remote RESET input: contact input.

### 1.3 Controls and Indications

The front panel of the FACP is as in Fig. 1-1.

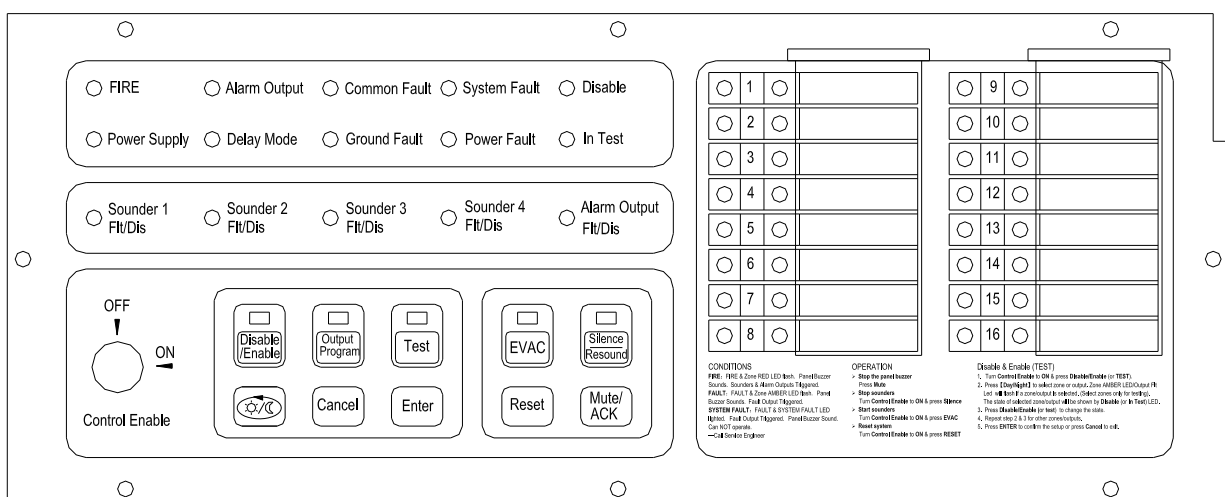

Fig. 1-1

#### 1.3.1 Common Status Indicators

- ✧ **FIRE:** It illuminates red steadily in fire condition.

- ◇ **Alarm Output:** It illuminates red steadily when the alarm output is activated.
- ◇ **Common Fault:** It flashes when the system enters a fault state and illuminates yellow steadily when the system enters safe state or *Mute/ACK* key is pressed.
- ◇ **System Fault:** It illuminates yellow steadily when the CPU is in fault condition. The system enters safe state at the moment.
- ◇ **Disable:** It illuminates yellow steadily if any zone or output is disabled.
- ◇ **Power Supply:** It illuminates green steadily when the FACP is powered up.
- ◇ **Delay Mode:** It illuminates yellow steadily when the system is in day mode (delay enabled) and it flashes when there is any output delayed.
- ◇ **Ground Fault:** It illuminates yellow steadily when there is ground fault.
- ◇ **Power Fault:** It illuminates yellow steadily when the power (including mains, batteries, charger and internal resistance) is in fault condition.
- ◇ **In Test:** It illuminates yellow steadily when a zone is in test condition.

### 1.3.2 Zone Status Indicators

- ◇ **Zone RED LED:** It flashes (0.5:0.5) when the zone is in fire condition. And it illuminates red steadily after *Mute/ACK* key is pressed.
- ◇ **Zone AMBER LED:** It flashes (0.5:0.5) when the zone is in fault condition. And it illuminates yellow steadily when the zone is disabled or in test.

### 1.3.3 Operating Indicators and Keys

- ◇ 5 keys with LEDs
  - **Disable/Enable:** Pressing this key can disable or enable an output or a zone and the LED illuminates green steadily.
  - **Output Program:** Pressing this key can set output program mode and the LED illuminates green steadily.
  - **Test:** Pressing this key can set test status and the LED illuminates green steadily.
  - **EVAC:** Pressing this key can start all sounders for evacuation and the LED illuminates red steadily when the sounders are started.
  - **Silence/Resound:** Pressing this key can silence all the sounders outputs; pressing it again in fire condition, the silenced sounders output will be activated again. The LED illuminates yellow steadily when the sounders are silenced.
- ◇ 5 keys
  - : Day/Night, for shifting operations and choosing Day or Night mode.
  - **Cancel:** For cancellation.
  - **Enter:** For confirmation.
  - **Reset:** For resetting the control panel.
  - **Mute/ACK:** Changing the silence status of the internal buzzer.
- ◇ 1 Control lock
  - **Control Enable:** For access level control. If it's switched to "OFF" position, the FACP is at the lowest access level, and only function keys under access level 1 are accessible.

### 1.3.4 Output Indicators

- ◇ **Sounder 1 Flt/Dis:** Yellow. It flashes when Sounder 1 output is in fault condition, and it illuminates steadily when Sounder 1 output is disabled.
- ◇ **Sounder 2 Flt/Dis:** Yellow. It flashes when Sounder 2 output is in fault condition, and it illuminates steadily when Sounder 2 output is disabled.
- ◇ **Sounder 3 Flt/Dis:** Yellow. It flashes when Sounder 3 output is in fault condition, and it illuminates steadily when Sounder 3 output is disabled.
- ◇ **Sounder 4 Flt/Dis:** Yellow. It flashes when Sounder 4 output is in fault condition, and it illuminates steadily when Sounder 4 output is disabled.

- ✧ **Alarm Output Fit/Dis:** Yellow. It flashes when alarm output is in fault condition and it illuminates steadily when Alarm Output is disabled.

### 1.3.5 Indicators of Control Board

The fault indicators on the control board are shown in Fig. 1-2.

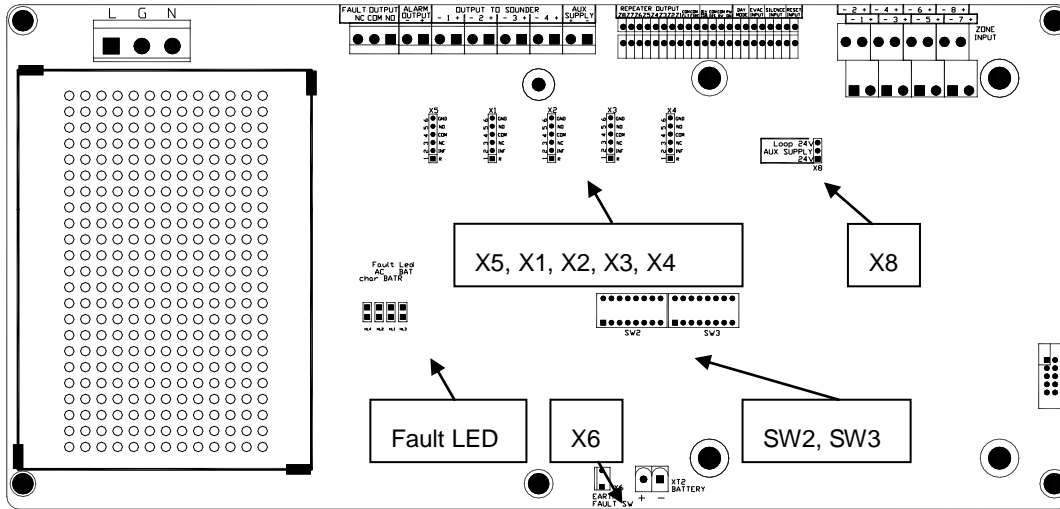

Fig. 1-2

- ✧ AC- It illuminates yellow steadily when mains power is in fault.
- ✧ BAT- It illuminates yellow steadily when standby power is in fault.
- ✧ Char- It illuminates yellow steadily when the internal charger is in fault.
- ✧ BATR- It illuminates yellow steadily when internal resistance of the batteries is too high.

## 1.4 Construction and Configuration

### 1.4.1 Appearance

The appearance of the FACP is shown in Fig. 1-3.

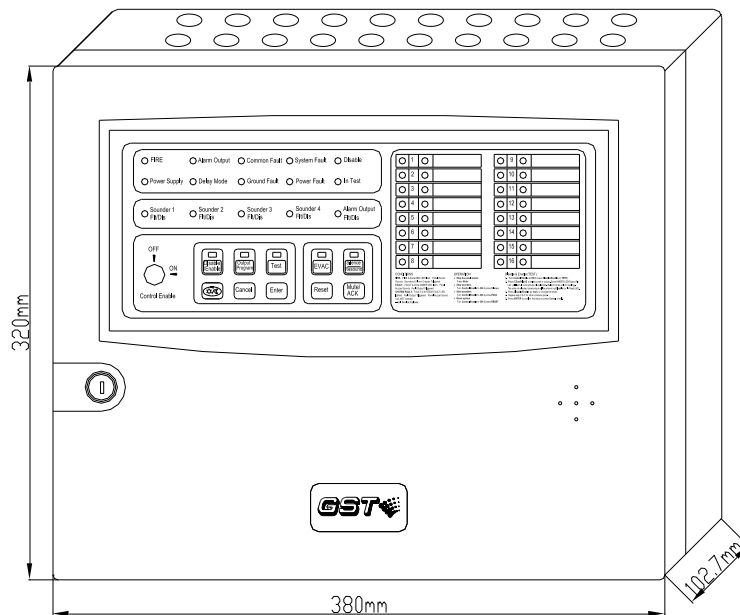

Fig. 1-3

## 1.4.2 Configuration

The internal construction of the FACP is shown in Fig. 1-4.

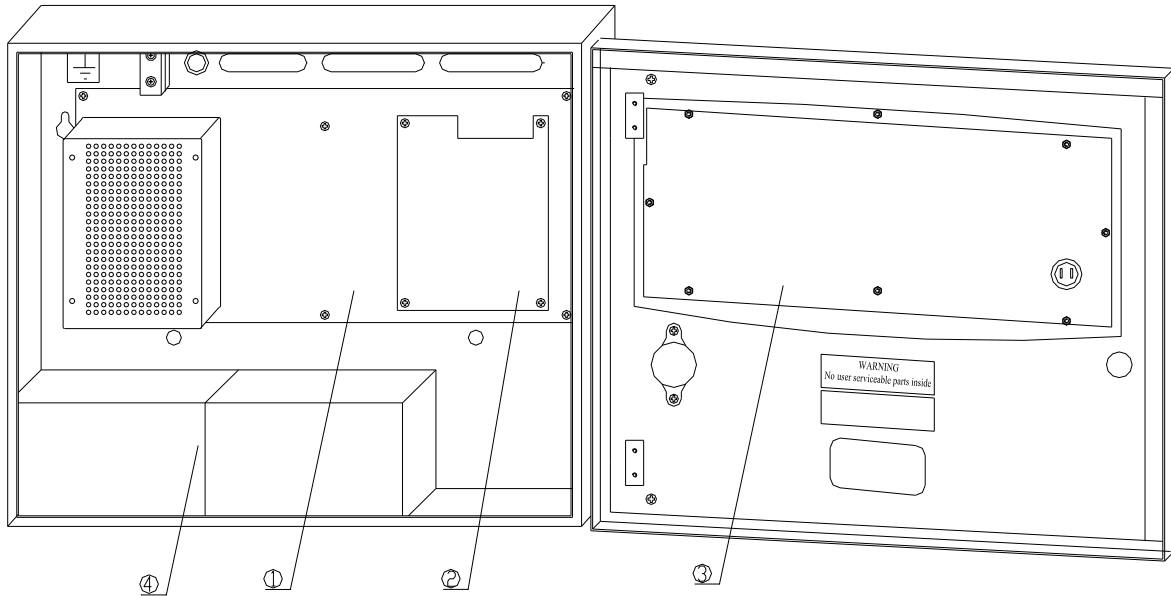

Fig. 1-4

- ① Control board    ② Extension board or signal output interface board    ③ Display board  
④ Batteries

### 1.4.2.1 Configuration of GST116A

#### 1.4.2.1.1 Typical configuration

- ✧ Control board: For controlling power supply, all outputs, detection input and repeater output for Zone 1 to 8.
- ✧ Extension board: Providing detection input and repeater output for Zone 9 to 16.
- ✧ Display board: For information display and key operation.
- ✧ Batteries: In case mains power is cut, the FACP can automatically switch to batteries to provide power supply for uninterrupted operation.

#### 1.4.2.1.2 Optional configuration

Signal output interface board is an optional part of GST116A panel that can replace the extension board by providing detection input and repeater output for Zone 9 to 16, as well as fire alarm output and fault output for Zone 1 to 16.

### 1.4.2.2 Configuration of GST108A

#### 1.4.2.2.1 Typical Configuration

- ✧ Control board: For controlling power supply, all outputs, detection input, and repeater output for Zone 1 to 8.
- ✧ Display board: For information display and key operation.
- ✧ Batteries: In case mains power is cut, the FACP can automatically switch to batteries to provide power supply for uninterrupted operation.

#### 1.4.2.2.2 Optional Configuration

Signal output interface board is an optional part for GST108A which provides fire alarm output and fault output for Zone 1 to 8.

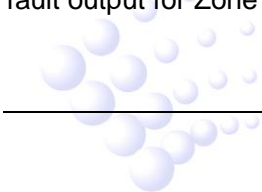

### 1.4.2.3 Configuration of GST104A

#### 1.4.2.3.1 Typical Configuration

- ✧ Control board: For controlling power supply, all outputs, detection input, and repeater output for Zone 1 to 4.
- ✧ Display board: For information display and key operation.
- ✧ Batteries: In case mains power is cut, the FACP can automatically switch to batteries to provide power supply for uninterrupted operation.

#### 1.4.2.3.2 Optional Configuration

Signal output interface board is an optional part for GST104A which provides fire alarm output and fault output for Zone 1 to 4.

### 1.4.2.4 Configuration of GST102A

#### 1.4.2.4.1 Typical configuration

- ✧ Control board: For controlling power supply, all outputs, detection input, and repeater output for Zone 1 to 2.
- ✧ Display board: For information display and key operation.
- ✧ Batteries: In case mains power is cut, the FACP can automatically switch to batteries to provide power supply for uninterrupted operation.

#### 1.4.2.4.2 Optional Configuration

Signal output interface board is an optional part for GST102A which provides fire alarm output and fault output for Zone 1 to 2.

## 1.5 Terminal Description

### 1.5.1 Terminals on the Control Board

Terminals on the control board are shown in Fig. 1-5.

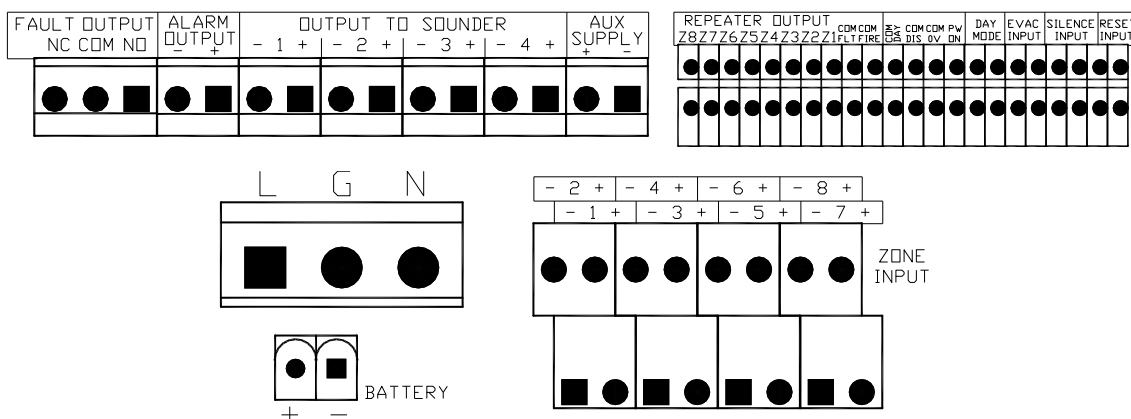

Fig. 1-5

- ✧ REPEATER OUTPUT: Output terminal for repeater panel connection.
  - PW ON: Power supply positive terminal for repeater panel connection.
  - COM 0V: Power supply negative terminal for repeater panel connection.
  - COM DIS: Disablement terminal for repeater panel connection.
  - COM DAY: Day mode terminal for repeater panel connection.
  - COM FIRE: Fire alarm terminal for repeater panel connection.
  - COM FLT: Fault terminal for repeater panel connection.
  - Z1~Z8: Zone indication terminals of repeater panel for Zone 1 to 8.

- ◇ AUX SUPPLY (+, -): Auxiliary power terminal.
- ◇ FAULT OUTPUT (NO, COM, NC): Fault output terminal.
- ◇ ALARM OUTPUT (+, -): Alarm output terminals.
- ◇ OUTPUT TO SOUNDER (1~4): Sounders output terminals.
- ◇ DAY MODE: Day/night mode conversion terminals.
- ◇ EVAC INPUT: For remote operation of EAVC.
- ◇ SILENCE INPUT: For remote operation of silence.
- ◇ RESET INPUT: For remote operation of reset.
- ◇ BATTERY (+, -): Battery terminals.
- ◇ L, G, N: Mains input terminals.
- ◇ ZONE INPUT (1~8): Zone 1 to 8 input terminals.

### 1.5.2 Terminals on GST116A Extension Board

Terminals on the extension board of GST116A are shown in Fig. 1-6.

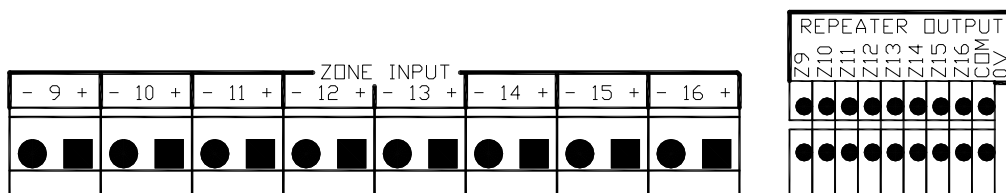

Fig. 1-6

- ◇ ZONE INPUT (9~16): Zone 9 to 16 input terminals.
- ◇ Z9~Z16: Zone indication terminals of repeater panel for zone 9 to 16.
- ◇ COM 0V: Power negative terminal for repeater panel.

### 1.5.3 Terminals on Signal Output Interface Board of GST116A

Terminals on signal output interface board of GST116A are shown in Fig. 1-7.

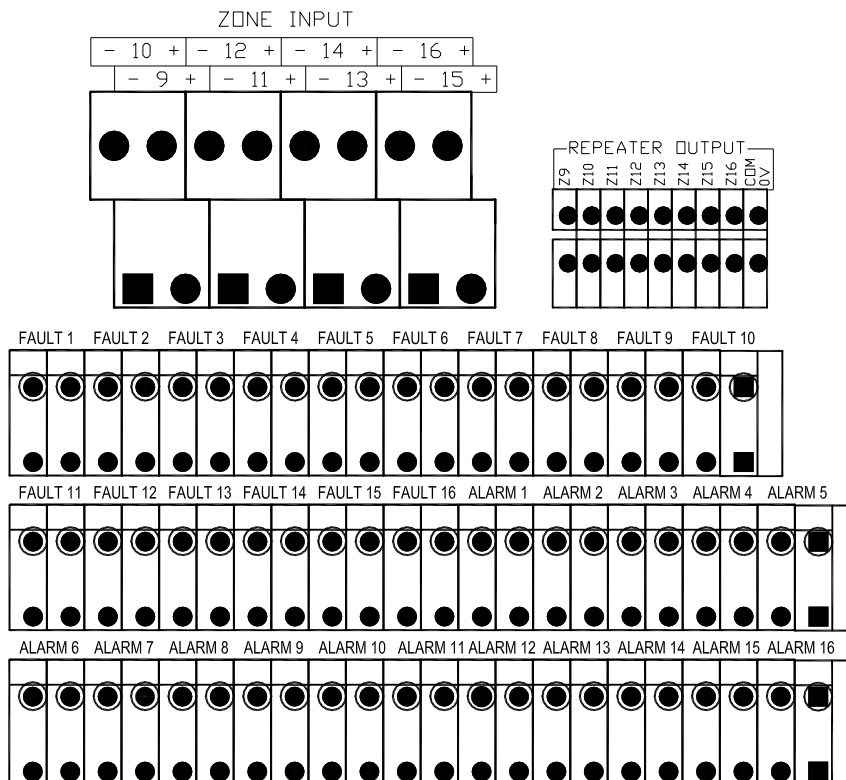

Fig. 1-7

- ◇ ZONE INPUT 9~16: Input terminals for zone 9 to 16.
- ◇ Z9~Z16: Indication terminals for zone 9 to 16 of the repeater panel.
- ◇ COM0V: Power negative terminal of the repeater panel.
- ◇ FAULT1~FAULT16: Fault output for zone 1 to 16.
- ◇ ALARM1~ALARM16: Alarm output for zone 1 to 16.

### 1.5.4 Terminals on Signal Output Interface Board of GST108A

Terminals on signal output interface board of GST108A are shown in Fig. 1-8.

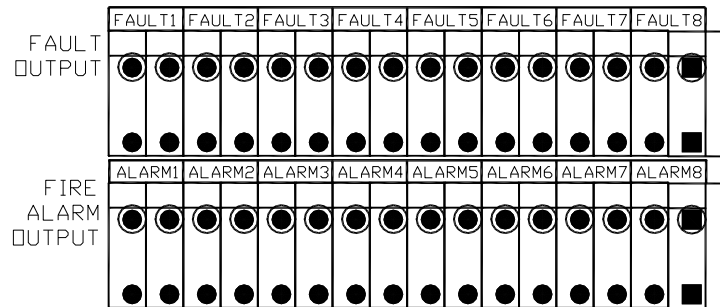

Fig. 1-8

- ◇ FAULT1~FAULT8: Fault output terminals for zone 1 to 8.
- ◇ ALARM1~ALARM8: Alarm output terminals for zone 1 to 8.

### 1.5.5 Terminals on Signal Output Interface Board of GST102A/104A

The terminals on the signal output interface board GST102A/104A are similar to GST108A, only with fewer outputs connected.

GST102A:

- ◇ FAULT1, FAULT2: Fault output for Zone 1 and 2.
- ◇ ALARM1, ALARM2: Alarm output for Zone 1 and 2.

GST104A:

- ◇ FAULT1~FAULT4: Fault output for Zone 1 to 4.
- ◇ ALARM1~ALARM4: Alarm output for Zone 1 to 4.

### 1.6 Dimensions

380mm×102.7mm×320mm (L X W X H)

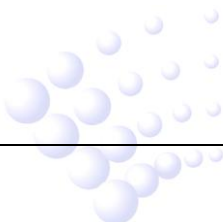



## Chapter 2 Installation

### 2.1 Installing the Cabinet

The FACP is wall-mounted as in Fig. 2-1.

**Note:** Cable connector should be installed in the knock-out hole to avoid cable abrasion and foreign objects.

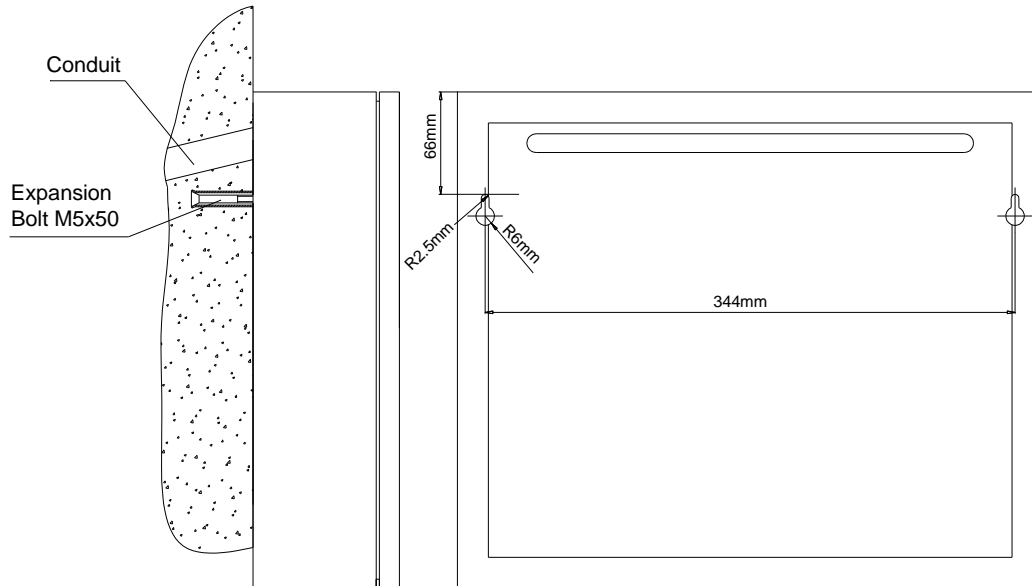

Fig. 2-1

### 2.2 Mains Connection

220/230VAC, 50/60Hz mains provide supply for GST108A FACP.

The incoming power cable Ground (Green/Yellow) wire should be connected to the G terminal and be reliably grounded. Connect the neutral (Blue) wire to terminal N and connect the Live (Brown) wire to terminal L.

It's recommended to use 1.5mm<sup>2</sup> or above shield cable subject to local installation codes.

**Note:**

- ✧ The power cables shall be fixed to the enclosure using a restraint clamp for strain relief.
- ✧ Do not power the system until the installation is completed.

### 2.3 Battery Connection

Refer to 5 Calculation of Batteries Capacity for the size of the required batteries.

Connect the batteries as in Fig. 2-2 and then to the battery terminal XT2 on the control board.

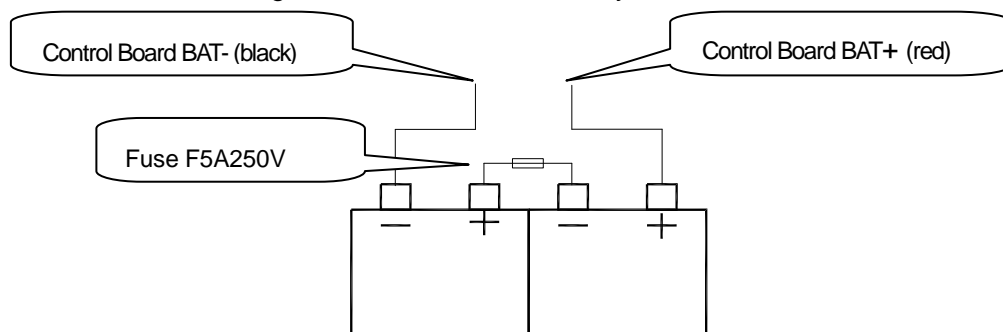

Fig. 2-2



**Note:**

- ✧ **Do not make battery connections until the installation is completed.**
- ✧ **The fuse of the batteries may be broken if the polarity is connected incorrectly.**

**2.4 Zone Input Connection**

Each zone can have maximum 15 fire detectors. The total number of detectors and call points in a zone should not exceed 32. They can be connected in two ways.

**2.4.1 Using end of line resistor**

Connect all manual call points in front of the detectors and put a 4.7kΩ resistor at the end of the loop, as shown in Fig. 2-3.

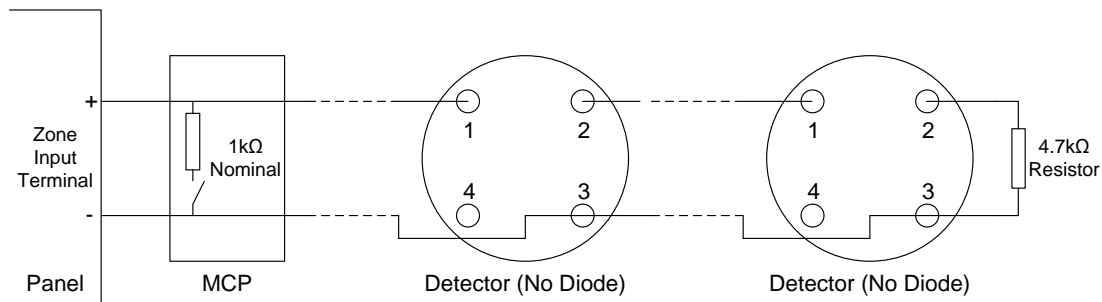

Fig. 2-3

**2.4.2 Using an Active End of Line Unit**

If an active end of line unit (AEOL) is used at the end of the loop, then the detectors and manual call points can be connected at any position. Ensure the detector base is fitted with a diode to keep the cable continuity in case any detector is removed, as shown in Fig. 2-4.

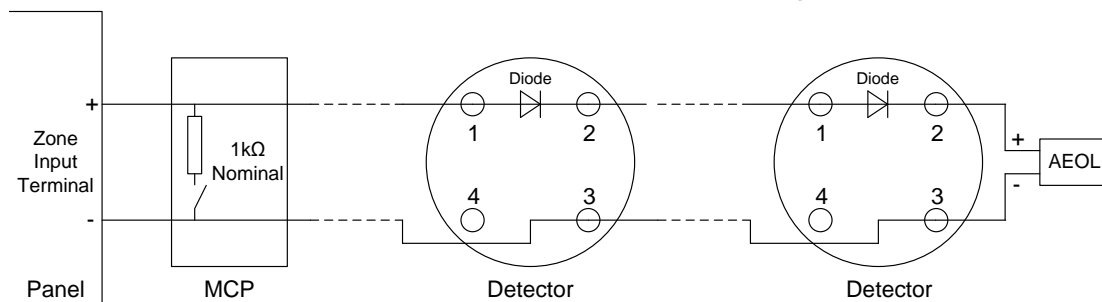

Fig. 2-4

**2.5 Sounder/Alarm Output Connection**

All sounders shall be polarity-sensitive and be connected in correct polarity. A 4.7kΩ resistor shall be connected in parallel at the end of the loop. Fig. 2-5 shows the connection of Sounder Output 1.

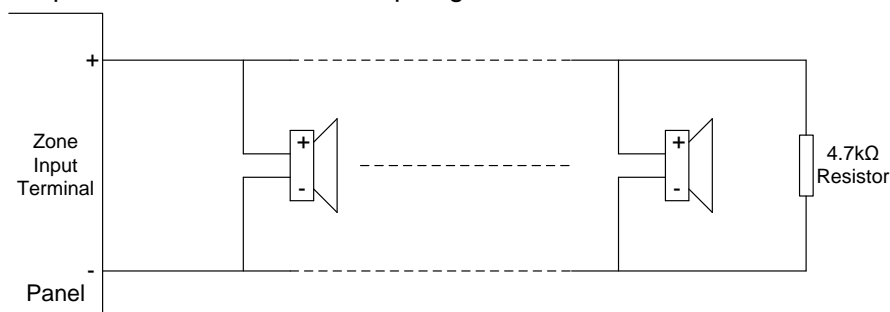
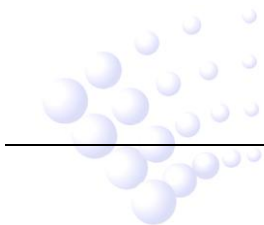

Fig. 2-5



## Chapter 3 System Setup

### 3.1 Setting Access Levels

The FACP provides three access levels:

- ✧ Level 1, for anybody to silence the buzzer by pressing *Mute/ACK* key.
- ✧ Level 2, for person on duty to disable, test, reset the panel, silence the sounders (using *Silence/Resound* key) and evacuate the building.
- ✧ Level 3, for special service engineer to turn on or off the FACP and program output modes.

#### 3.1.1 Setting Access Level 1

Turning Control Enable lock “OFF” shown as in Fig. 3-1, the FACP is set to access level 1. “1” of SW2 on control board should be at OFF (LEVEL 3) position as shown in Fig. 3-2. SW2 and SW3 are on the control board shown in Fig. 1-2.

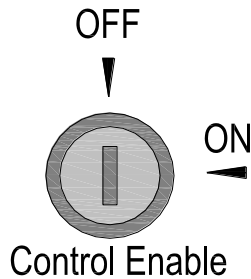

Fig. 3-1

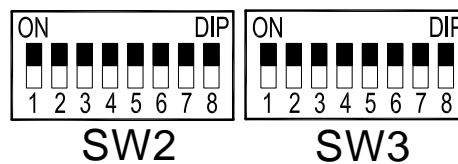

Fig. 3-2

(White cell indicates the position of switch)

#### 3.1.2 Setting Access Level 2

Turning Control Enable lock “ON” shown as in Fig. 3-3, the FACP is set to access level 2. “1” of SW2 should be at OFF position as shown in Fig. 3-2.

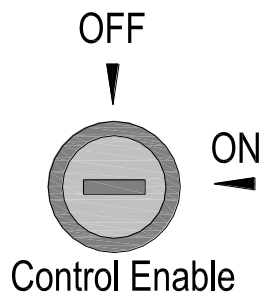

Fig. 3-3

#### 3.1.3 Setting Access Level 3

If “1” of SW2 (Level 3) is set to ON position as shown in Fig. 3-4, whichever position the Control Enable lock is, the FACP is set to access level 3.

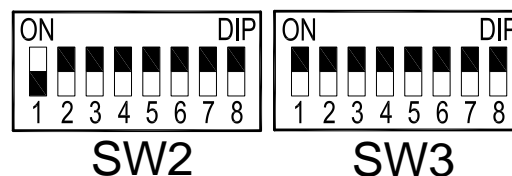
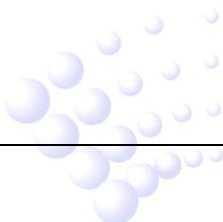

Fig. 3-4

(White cell indicates the position of switch)



### 3.2 Setting Sounder/Alarm Output

4 sounder outputs and 1 alarm output can be set through Pins (Pins X1, X2, X3, X4 and X5 is respectively corresponded to sounder output of zone 1 to 4 and alarm output ) on the control board to one of the three types including voltage output, normally open contact output or normally closed contact output. The default setting is voltage output.

#### 3.2.1 Example for Setting Voltage Output

Connecting “2” with “3” and “5” with “6” of Pin X1 using jumpers will set Sounder 1 as voltage output, refer to Fig. 3-5.

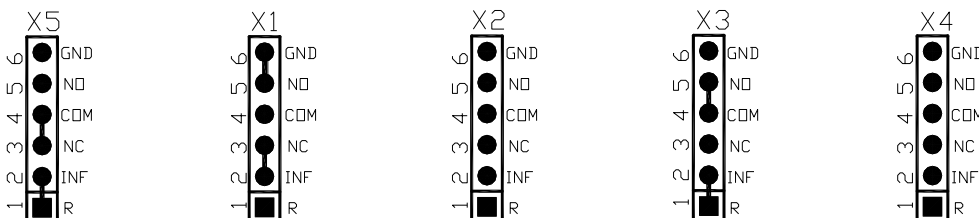

Fig. 3-5

#### 3.2.2 Example for Setting Normally Open Output

Connecting “1” with “2” and “4” with “5” of Pin X3 using jumpers will set Sounder 3 as normally open contact output, refer to Fig. 3-5.

#### 3.2.3 Example for Setting Normally Closed Output

Connecting “1” with “2” and “3” with “4” of X5 using jumpers will set Alarm Output as normally closed contact output, refer to Fig. 3-5.

Please refer to Table 3-1 for detailed settings for sounder output and alarm output.

Table 3-1

Output	Normally closed contact	Normally open contact	Voltage output
	Jumpers	Jumpers	Jumpers
Sounder 1	X1/ 1&2, 3&4	X1/ 1&2, 4&5	X1/ 2&3, 5&6
Sounder 2	X2/ 1&2, 3&4	X2/ 1&2, 4&5	X2/ 2&3, 5&6
Sounder 3	X3/ 1&2, 3&4	X3/ 1&2, 4&5	X3/ 2&3, 5&6
Sounder 4	X4/ 1&2, 3&4	X4/ 1&2, 4&5	X4/ 2&3, 5&6
Alarm output	X5/ 1&2, 3&4	X5/ 1&2, 4&5	X5/ 2&3, 5&6

### 3.3 Disablement of a Zone or Output

#### 3.3.1 Use of Disablement Function

In case there is any fault with a detection zone or a sounder/alarm output, it can be disabled so that it does not affect normal operation of other zones. After the fault is removed, the disabled detection zone or output can be enabled again. This operation applies to the 16 detection zones, 4 sounder outputs, and 1 fire alarm output.

The setting operation can be indicated by Disable/Enable key & indicator, Disable indicator and zone indicators. There are instructions for disablement operation on the front panel.

#### 3.3.2 Operation Steps

- 1 Enter Access Level 2 as described in Section 3.1.2.
- 2 Pressing *Disable/Enable* key, *Disable/Enable* LED illuminates steadily and the amber LED of Zone 1 starts flashing to show Zone 1 is selected for disablement setup. Common Fault LED will indicate a system fault condition. Other indicators, except for the above mentioned LEDs,

- will be turned off.
- 3 Pressing  key will switch the selected zone or output among Zone 1 to 8, Sounder outputs and Alarm Output.
  - 4 The amber LED for Zone 1 to 8 will flash when the zone is selected. Pressing *Disable/Enable* key can choose whether or not to disable the selected zone. The illuminating *Disable* LED indicates the zone is disabled.
  - 5 For 4 sounder outputs, the *Sounder X Flt/Dis* LED will flash when it's selected. Pressing *Disable/Enable* key can choose whether or not to disable it. The illuminating *Disable* LED indicates the sounder outputs are disabled.
  - 6 For Alarm Output, *Alarm Output Flt/Dis* LED will flash if it's selected. Pressing *Disable/Enable* can choose whether or not to disable it. The illuminating *Disable* LED indicates the alarm output is disabled.
  - 7 Press *Enter* to save the current settings and exit after all settings have been finished. The FACP will give 1s sound indication. Press *Cancel* to exit the programming mode without saving.
  - 8 Pressing *Cancel* again exits disablement setting status and *Disable/Enable* LED turns off.
  - 9 Exit Access level 2.

**Note: Disable status setting can be saved even if the FACP is powered off.**

### 3.4 Setting Test Mode

#### 3.4.1 Use of Test Mode

Test mode is for testing if a zone works normally. In this mode, if a zone can generate a fire alarm signal when it's manually put into fire condition, it shows this zone works properly. Alarm Output will not be activated, and sounders can be programmed to either output for 15s or not output.

#### 3.4.2 Operation Steps

- 1 Enter Access Level 2 as described in Section 3.1.2.
- 2 Pressing *Test*, *Test* LED illuminates steadily. The amber LED of Zone 1 starts flashing, showing the system is in test mode and Zone 1 is selected. Common Fault LED will indicate a system fault condition. Other indicators, except for the above mentioned LEDs, will be turned off.
- 3 Pressing  will switch the zone number from 1 to 8.
- 4 Zone *AMBER* LED for Zone 1 to 8 will flash when the zone is selected. Pressing *Test* can choose to set test mode ON or OFF. The illuminating *In Test* LED indicates the zone is in test mode.
- 5 Press *Enter* to save the current settings and exit after all settings have been finished. The FACP will give 1s sound indication. Pressing *Cancel* will not save the setting.
- 6 Press *Cancel* to exit test mode. *Test* LED turns off.
- 7 Exit Access Level 2.

**Note: Test mode can not be saved if the FACP is powered off.**

### 3.5 Programming Output Modes

All output settings have to be done under Access Level 3. So before setting the outputs, please

first set the system to Level 3 according to the instructions in Section 3.1.3.

The FACP can be programmed through keypad for the functions below:

- ✧ Setting the system to default status;
- ✧ Setting a zone “With Manual Call Point”. If a zone is set “With Manual Call Point”, a fire alarm from the zone will activate its associated sounders and the system Alarm Output, regardless of whether the zone is set with delayed output or not;
- ✧ Associating a zone with sounders. The output mode, sound pattern, and delay time of the sounders associated to the zone can be set respectively.
- ✧ Setting delay time for Alarm Output.

### 3.5.1 Setting the FACP to Default

#### 3.5.1.1 Features of system default

- ✧ All zones are set as “With Manual Call Point”.
- ✧ Alarm from any zone will activate all sounders. The sounders will output a continuous alarm sound (EVAC mode) without any delay.
- ✧ Alarm Output is activated without any delay.
- ✧ There is no disabled zone or output.

#### 3.5.1.2 Steps for setting the system to default status

The system provides a quick method to set the system to default:

- 1 Enter Access Level 3 as described in Section 3.1.3;
- 2 Press and hold *Output Program* for more than 2 seconds, and the system will enter default state with 1s sound indication.
- 3 Exit Access Level 3.

### 3.5.2 Setting “With Manual Call Point”

The purpose of this feature is to ensure that activating a manual call point in field will immediately generate a fire alarm in the system. If a zone is set “With Manual Call Point”, any fire alarm coming from that zone (either from a detector or a manual call point), the FACP will immediately alarm and activate all sounders associated to that zone and the system Alarm Output regardless of any delay setting. At the same time, delay to outputs is overridden. This function can be applied to all detection zones. Basic steps are shown below.

- 1 Enter Access Level 3 as described in Section 3.1.3;
- 2 Set “2” of SW2 (CFG MCP ZONE) on control board to ON position.
- 3 Pressing *Output Program*, Output Program LED illuminates steadily and the amber LED of Zone 1 flashes to show Zone 1 is selected for “With Manual Call Point” setup. *Common Fault* LED will indicate a system fault condition. Other indicators, except for the above mentioned LEDs, will be turned off.
- 4 Pressing  will switch the zone number from 1 to 8.
- 5 The amber LED for Zone 1 to 8 will flash when the zone is selected. Pressing *Output Program* key can choose whether or not to program the zone as “With Manual Call Point” or not. The illuminating *Delay Mode* LED indicates the zone is not programmed as “With

Manual Call Point”.

- 6 Press *Enter* to save the current settings and exit after all settings have been finished. The FACP will give 1s sound indication. Pressing *Cancel* will not save the setting.
- 7 Press *Cancel* to exit the programming mode and *Output Program* LED turns off.
- 8 Set “2” of SW2 to OFF position.
- 9 Exit Access Level 3.

**Note:**

**If one of the outputs (sounders or Alarm Output) is programmed with delay, then there should be at least one zone set as “With Manual Call Point” to ensure the delay could be overrode for immediate output.**

**3.5.3 Setting Associated Sounders of a Zone**

Output state, output mode and delay time of sounders can be set separately for each detection zone.

Four output modes are shown in Table 3-2.

Table 3-2

Mode	Description	Disable/Enable LED	Test LED
1	No output	Off	Off
2	If alarm relay outputs, it outputs.	Off	On
3	Delay output	On	Off
4	Immediate output	On	On

Two sounder patterns are shown in Table 3-3.

Table 3-3

Sounder Patterns	“5” of SW3 (Sounder Mode)
Alert mode, pulse output	Off
Evacuation mode, continuous output	On

Delay can be calculated as shown in Table 3-4.

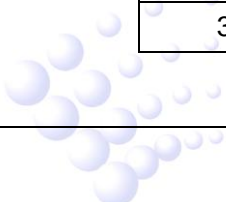

Table 3-4

Delay (min)	“1” to “4” of SW3 (Delay)			
	1	2	3	4
0	Off	Off	Off	Off
0.5	on	Off	Off	Off
1	Off	on	Off	Off
1.5	on	on	Off	Off
2	Off	Off	on	Off
2.5	on	Off	on	Off
3	Off	on	on	Off
3.5	on	on	on	Off



4	Off	Off	Off	on
4.5	on	Off	Off	on
5	Off	on	Off	on
5.5	on	on	Off	on
6	Off	Off	on	on
6.5	on	Off	on	on
7	Off	on	on	on
7.5	on	on	on	on

Operation steps of zone association output setting are shown below.

- 1 Enter Access Level 3 as described in Section 3.1.3.
- 2 Set the “3” of SW2 (CFG Zonal output) on control board to ON position.
- 3 Pressing *Output Program* key, *Output Program* LED illuminates steadily and the amber LED of Zone 1 flashes to show Zone 1 is selected for setting up associated sounders. *Common Fault* LED will indicate a system fault condition. Other indicators, except for the above mentioned LEDs, will be turned off.
- 4 Pressing  will shift the zone from 1 to 8.
- 5 When a zone is selected, press *Output Program* key to set up its associated zones. *Flt/Dis* LED of Sounder1 flashes, showing Sounder1 has been selected for setup.
- 6 Pressing  will shift from Sounder1 to Sounder4.
- 7 Pressing *Disable/Enable* or *Test Key* can respectively switch on or off their indicator. *Disable/Enable Key & LED* and *Test Key & LED* are used for setting up and indicating the output logic of the selected sounder, as shown in Table 3-2.
- 8 Switching “5” of SW3 (Sounder Mode) on or off can change the sound pattern of the selected sounder (refer to Table 3-3).
- 9 “1” to “4” of SW3 are used for setting the delay time of the selected sounder (refer to Table 3-4).
- 10 Press *Enter* to save and exit the current settings. The FACP will sound for 1s to indicate the successful setup. Repeat Step 6 to 9 to set another sounder for this zone.
- 11 Press *Cancel* to exit setup for this zone without saving and return to zone selection step. Repeat Step 4 to 10 to select another zone for setup.
- 12 At zone selection step, pressing *Cancel* again will exit programming mode. *And Output program* LED will be turned off.
- 13 Set “3” of SW2 (CFG Zonal Output) to OFF position.
- 14 Exit Access Level 3.

### 3.5.4 Setting Delay Time of Alarm Output

Delay time of Alarm Output can be set through the following steps.

- 1 Enter Access Level 3 as described in Section 3.1.3.
- 2 Set “4” of SW2 to ON position.
- 3 Pressing *Output Program* key, *Output Program* LED illuminates steadily and *Alarm Output*

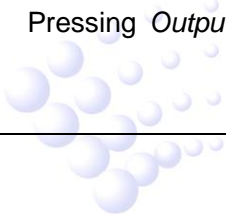



*Flt/Dis* LED flashes.

- 4 “1” to “4” of SW3 are used for setting the delay time of Alarm Output (refer to Table 3-4).
- 5 Pressing *Enter* to save the setting. The FACP will sound for 1s to indicate the successful setup. Pressing *Cancel* will not save the setting.
- 6 Pressing *Cancel* will exit programming mode and *Output Program* LED turns off.
- 7 Set “4” of SW2 (CFG alarm output-Delay) to OFF position.
- 8 Exit Access Level 3.

### 3.6 Setting Auxiliary Functions

- ✧ Resound mode: When “5” of SW2 is set to ON position, Resound mode is turned on. When there is fire alarm from a zone, the sounders associated to this zone will be started. Pressing *Silence* on the FACP, these sounders can be silenced; if there is an alarm signal from another zone at this moment, the silenced sounders that are not associated to this new alarm zone will resound. If Resound mode is turned off, the silenced sounders not associated to this new alarm zone will remain silenced.
- ✧ Silence-Reset mode: When “6” of SW2 is set to ON position, Silence-Reset mode is turned on. When there is fire alarm from a zone and its associated sounders are started, the FACP will not be reset until the sounders are silenced. If Silence-Reset mode is turned off, the FACP can be reset immediately.
- ✧ Silence-Delay mode: When “7” of SW2 is set to ON position, Silence-Delay mode is turned on. When there is fire alarm from a zone and its associated sounders are started, the FACP has to stay in fire condition for 3 minutes before the sounders could be silenced. If Silence Delay mode is turned off, the sounders can be silenced immediately.
- ✧ Test Zone Silence mode: When “8” of SW2 is set to ON position, Test Zone Silence mode is turned on. When a zone is in Test mode and there is an alarm signal coming from the zone, the sounders associated to the zone will be automatically activated for 15s. If Test Zone Silence mode is turned off, the sounder will not be activated.

### 3.7 Ground Fault Checking and Auxiliary Power Setting

- ✧ Shorting X6 (EARTH FAULT) with a jumper, refer to Fig.3-6. The FACP will be able to check earth fault. Otherwise, the earth fault can't be checked.
- ✧ Setting auxiliary power output: If the devices powered by Aux. 24V require steady output, you can connect 24V and AUX SUPPLY of X8 (refer to Fig. 3-6) with a jumper. If they are to be reset together with the FACP, you can connect Loop 24V and AUX Supply with a jumper, so that AUX Supply stops output for about 3 seconds when the panel resets.

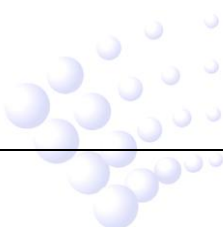



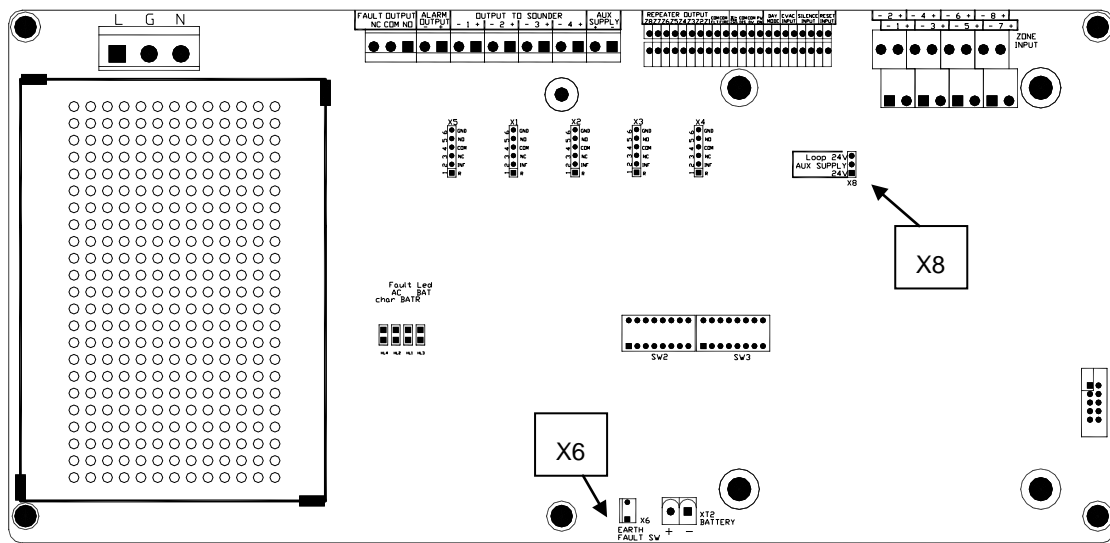
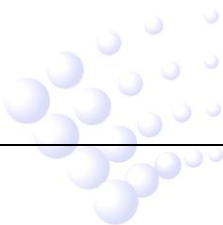

Fig. 3-6



## Chapter 4 Operation Instructions

### 4.1 Working State Description

#### 4.1.1 State of Detection Zones

- ✧ Fire: If there is a zone in fire condition, *FIRE* LED and zone red LED flash (0.5s:0.5s). Pressing *Mute/ACK* key, they will illuminate steadily.
- ✧ Fault: If there is a zone in fault condition, *Common Fault* LED and zone amber LED flash. Pressing *Mute/ACK* key, *Common Fault* LED illuminates steadily and zone amber LED remains flashing.
- ✧ Disabled: If there is a zone disabled, *Disable* LED and zone amber LED illuminate steadily.
- ✧ Normal: If a zone is in normal condition, the Zone red and amber LEDs should both be off.

#### 4.1.2 Alarm Output State

- ✧ Action: If the Alarm Output is activated, *Alarm Output* LED illuminates steadily.
- ✧ Fault: If there is a fault, *Common Fault* LED and *Alarm Output Flt/Dis* LED flash. Pressing *Mute/ACK* key, *Common Fault* LED illuminates steadily, *Alarm Output Flt/Dis* LED remains flashing.
- ✧ Disabled: If Alarm Output is disabled, *Disable* LED and *Alarm Output Flt/Dis* LED illuminate steadily.
- ✧ Normal: If Alarm Output is in normal condition, *Alarm Output Flt/Dis* LED should be off.

#### 4.1.3 Sounder Output State

- ✧ Fault: If there is a fault with any of the sounders, *Common Fault* LED and *Sounder X Flt/Dis* LED flash. Pressing *Mute/ACK* key, *Common Fault* LED illuminates steadily and *Sounder X Flt/Dis* LED remains flashing.
- ✧ Disabled: If any of the 4 sounder outputs is disabled, *Disable* LED and *Sounder X Flt/Dis* LED illuminate steadily.
- ✧ Normal: If a sounder output is in normal condition, *Sounder X Flt/Dis* LED should be off.

#### 4.1.4 Safe State

When there is fault with any CPU or circuit that makes the FACP unable to work properly or changes system data, the FACP will enter safe state.

- ✧ *Common Fault* and *System Fault* LED illuminate.
- ✧ The buzzer sounds continuously.
- ✧ The keypad cannot be operated.
- ✧ The FACP cannot monitor fire.
- ✧ Fault output is activated.
- ✧ Other outputs remain the states before the FACP enters safe state.
- ✧ Other indicators remain the states before the FACP enters safe state.
- ✧ Safe state can only be cleared by re-powering the FACP.

#### 4.1.5 Description of the Buzzer

The buzzer of the FACP sounds by priority coming from high to low as follows: Safe state, Fire, Fault, and Normal. The sound patterns of the buzzer are:

- ✧ Safe state, sounds steadily.
- ✧ Fire alarm, 0.5s on, 0.5s off.
- ✧ Fault, 2s on, 2s off.
- ✧ Normal, no sound.

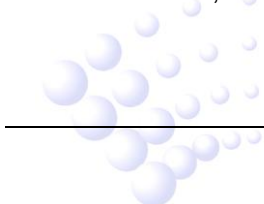

#### 4.1.6 Notes

- ✧ Access levels are downwards applicable. A higher level enables access at levels lower than it.
- ✧ If there is no key pressed for over 3 minutes or if the access level is changed, all previous operation will be canceled and the FACP would return to normal standby state.
- ✧ Remote EVAC INPUT, SILENCE INPUT and RESET INPUT are contact input type. If an input is shorted for 2s, the FACP will operate correspondingly regardless of access levels.
- ✧ A delayed sounder output is only valid if all of the following conditions are met:
  - The sounder is associated with a zone and is programmed with delay.
  - The FACP is in Day mode.
  - There is no manual call point in the associated zone.
  - This sounder output is not activated, not in fault or disabled condition.
  - If fire alarm comes from the associated zone, the sounder will output with a delay and *Delay Mode* LED flashes.

Note:

- If a sounder is activated with delay, and another zone is also associated with this sounder but is programmed as immediate output, then a fire alarm from this zone will override the delay and activate the sounder immediately.
- If a sounder is activated with delay, and another zone is also associated with this sounder but is programmed with a delay time shorter than the remaining delay time, then a fire alarm from this zone will override the previous delay and activate the sounder with the shorter delay time.
- ✧ Sounders and Alarm Output will not be activated if they are disabled or in fault.

#### 4.2 Acknowledgement and Silence of Fault

A fault condition can be acknowledged and silenced at access level 1.

Pressing Mute/ACK under a fault condition, the buzzer of the FACP will be mute and the fault is acknowledged. *Common Fault* LED will illuminate steadily.

#### 4.3 Acknowledgement and Silence of Fire Alarm

A fire alarm can be acknowledged and silenced at access level 1.

Pressing *Mute/ACK* under fire alarm condition, the buzzer of the FACP will be mute and the alarm is acknowledged. *FIRE* LED and zone red LED will light. If there is a new fire alarm from another zone, the zonal red LED will flash. Pressing *Mute/ACK*, it will illuminate steadily.

#### 4.4 Silencing the Sounders

The sounders can be silenced at access level 2.

Pressing *Silence/Resound* can silence the sounders. In fire alarm state, pressing *Silence/Resound* will silence the sounders and pressing it again will make them resound.

If the SILENCE INPUT contact is shorted for over 2s, the FACP will silence the sounders regardless of the current access level.

#### 4.5 Evacuation

The evacuation can be operated at access level 2.

Pressing *EVAC* key, all sounders will enter EVAC mode to sound continuously.

If the EVAC INPUT contact is shorted for 2s, the FACP will activate EVAC function to start all sounders regardless of the current access level.

#### 4.6 Self-test and Reset

Self-test and Reset can be carried out at access level 2.

The FACP will start self-test on power-up. Pressing *Reset* can clear all audio and visual indication

and carry out self-test. The self-test can check all indicators and the buzzer. All indicators illuminate and the buzzer sounds. After self-test, the panel returns to normal condition.

If the RESET INPUT contact is shorted for over 2s, the FACP will start reset and self-test regardless of the current access level.

#### **4.7 Setting Day/Night Mode**

Day and night mode is related with output delay. If there is person on duty, you can set the panel to Day mode, thus any fire alarm output will be delayed for confirmation to avoid false alarm. If there is nobody on duty, you can set the panel to Night mode, so that the FACP will alarm immediately on receiving a fire signal. There are two ways to shift between Day/Night modes.

- ◇ DAY MODE input signal is closed to force the FACP to Night mode.
- ◇ Pressing  for 2 seconds at access level 2 will change the Day/Night Mode. The panel gives 1s sound for indication. If Day mode is selected, the Delay Mode LED illuminates. If Night Mode is selected, the Delay Mode LED turns off.

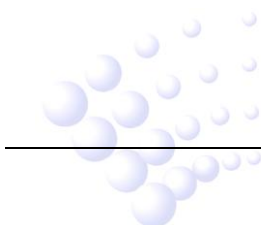

## Chapter 5 Calculation of Batteries Capacity

The formula for calculating batteries capacity is as follows:

$$\text{Batteries Capacity (Ah)} = (I_{Q_{\max}} + I_{Q_{\text{out}}}) \times T_1 + (I_{Q_{\min}} + I_{L_{\max}} + I_{F_{\text{out}}}) \times T_2$$

In which,

$I_{Q_{\max}}$  is the maximum standby current of the FACP in full load, which is 0.12A (calculated based on 16 zones).

$I_{Q_{\text{out}}}$  is the auxiliary output current in standby condition, which is 0.02A

$I_{Q_{\min}}$  is the FACP circuit consumption in fire condition, which is 0.1A.

$I_{L_{\max}}$  is the loop maximum current allowed for 16 detection zones, which is 0.4A.

$I_{F_{\text{out}}}$  is the output current in alarm condition, which is 2A (1.5A for 4 sounder outputs and 1 fire alarm output, and 0.5A for the auxiliary output).

$T_1$  is the time for the batteries to work in monitoring status which shall be 24 hours by EN 54-4 standard.

$T_2$  is the time for the batteries to work in alarm status which shall be 30 minutes by EN 54-4 standard.

From the above, we can get the maximum battery capacity is 4.61AH, so that we recommended a 7AH battery to be used for the system. And as the above calculations are based on the 16-zone GST116A, they are also applicable to GST102A, GST104A and GST108A.

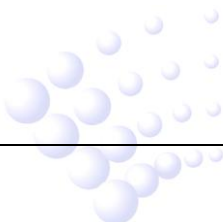

## Chapter 6 Servicing

The FACP shall be serviced by specially trained engineers. Please disconnect power before servicing.

### 6.1 Replacing the Batteries

- ✧ Type: Sealed lead-acid battery.
- ✧ Recommend period for replacement: 5 years (25°C)
- ✧ Recommended manufacturer and model: Yuasa NP7-12
- ✧ Disposal of used batteries: Please properly dispose the used batteries according to your local rules and regulations.

**WARNING: RISK OF EXPLOSION IF BATTERIES ARE REPLACED BY AN INCORRECT TYPE!**

### 6.2 Replacing the Fuses

Position	Mark	Rated value
Control Board F7.820.1675	F1	CT 2AH250V
Battery Connection Cable	5A	F 5A250V

#### 6.2.1 Cautions

**6.2.1.1** Please disconnect power before replacing the fuse.

**6.2.1.2** For F1, please replace it with correct rated fuses.

**6.2.1.3** For F1, please follow the steps below:

- 1) Remove the protective cover from the control board, and you will see the fuse F1.
- 2) Remove the fuse cover and replace the fuse.
- 3) After replacement, put back the fuse cover and the protective cover.

**6.2.1.4** Follow the steps below to replace 5A fuse.

- 1) Unfasten the fuse holder in the battery connection to find 5A fuse.
- 2) Replace the 5A fuse
- 3) Fasten the fuse holder.

### 6.3 Troubleshooter

No.	Problem	Possible Reason	Resolution
1	No LED lights on power-up	a. AC input fuse F1 is blown. b. Power supply doesn't work properly. c. Connection between the control board and display board is loose.	a. Replace the fuse. b. Replace the control board. c. Check and reconnect the cable.
2	Reports AC fault or batteries fault on power-up	a. Mains power is not applied or mains input fuse is blown. b. Batteries are not fitted or 5A fuse is blown. c. low batteries.	a. Check and apply AC power and replace the fuse F1 on the control board. b. Connect the batteries or replace 5A fuse. c. If the problem still exists after the FACP has been applied with AC power for over 24 hours, please replace the batteries.
3	Incorrect report on detection zone status or output status	a. Pin X1 to X5 on the control board are not set correctly. b. Control board damaged.	a. Check settings of X1 to X5 b. Replace the control board.
4	Settings cannot be saved	CPU D6 on the control board is damaged	Replace the control board.
5	The lock cannot be	Connection line of lock is loose.	Check the connection.

operated.

### Appendix 1 Wiring Diagram for GST116A FACP

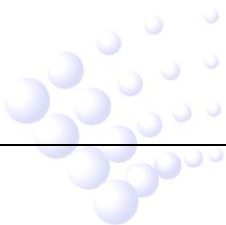
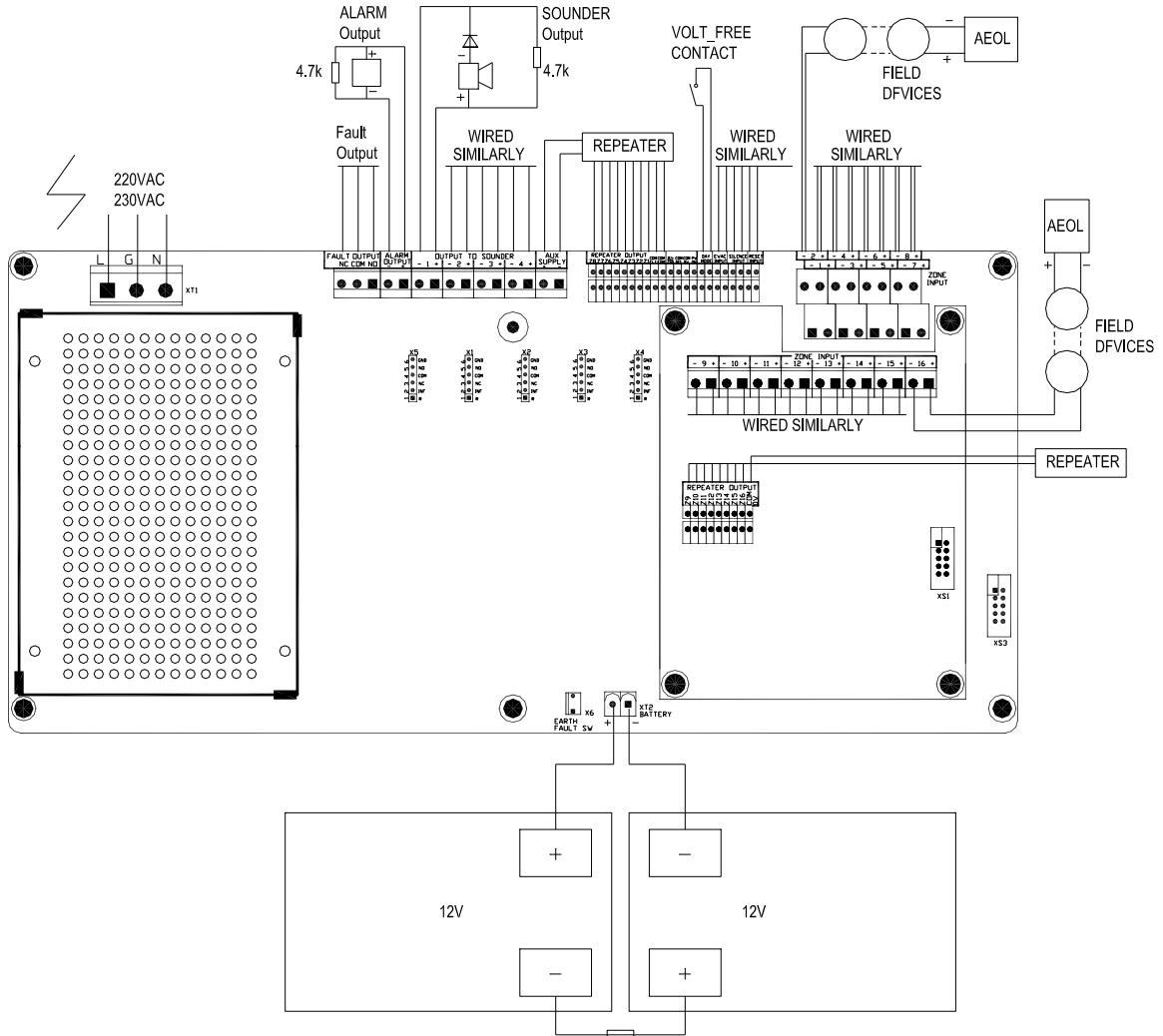

## Appendix 2 Wiring Diagram for GST108A FACP

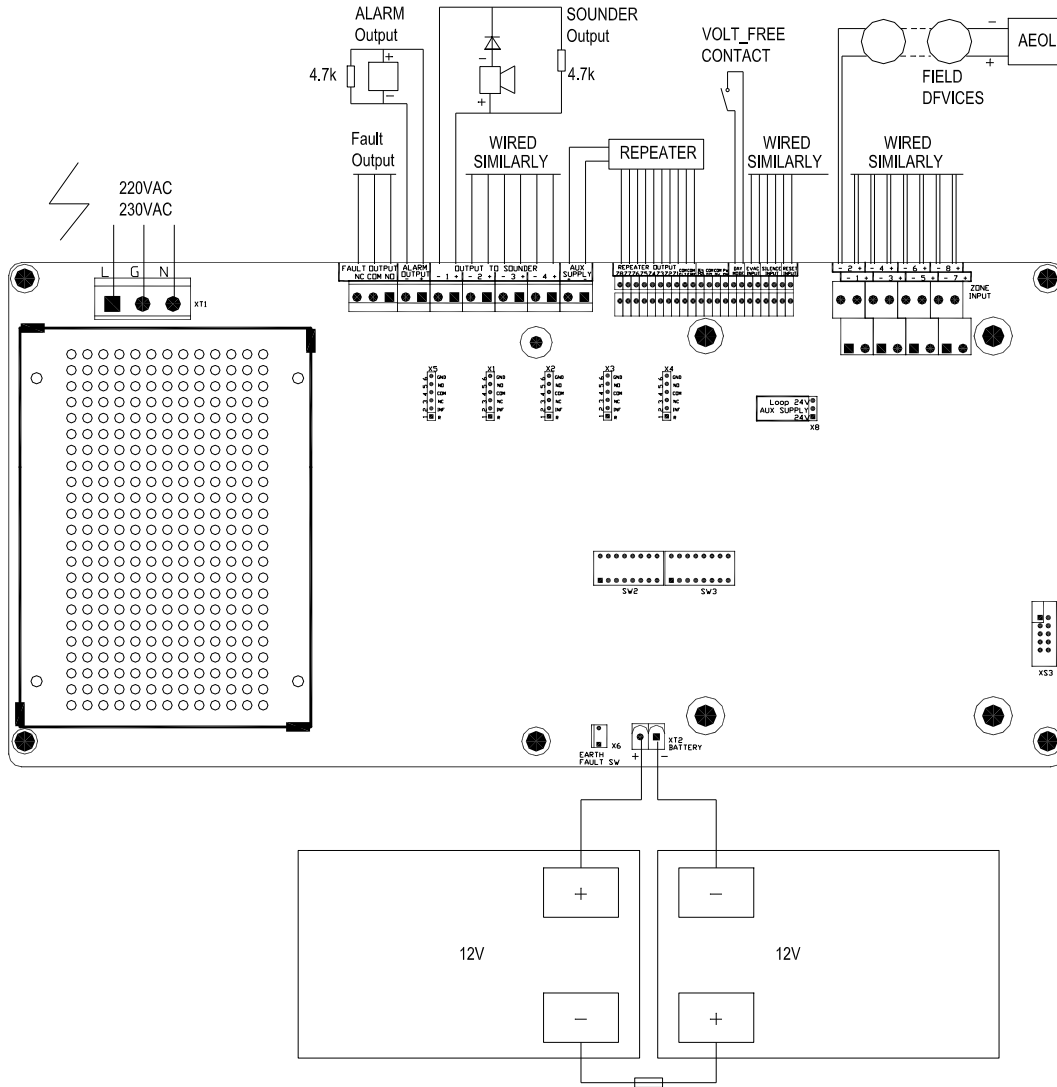



### Appendix 3 Wiring Diagram for GST104A FACP

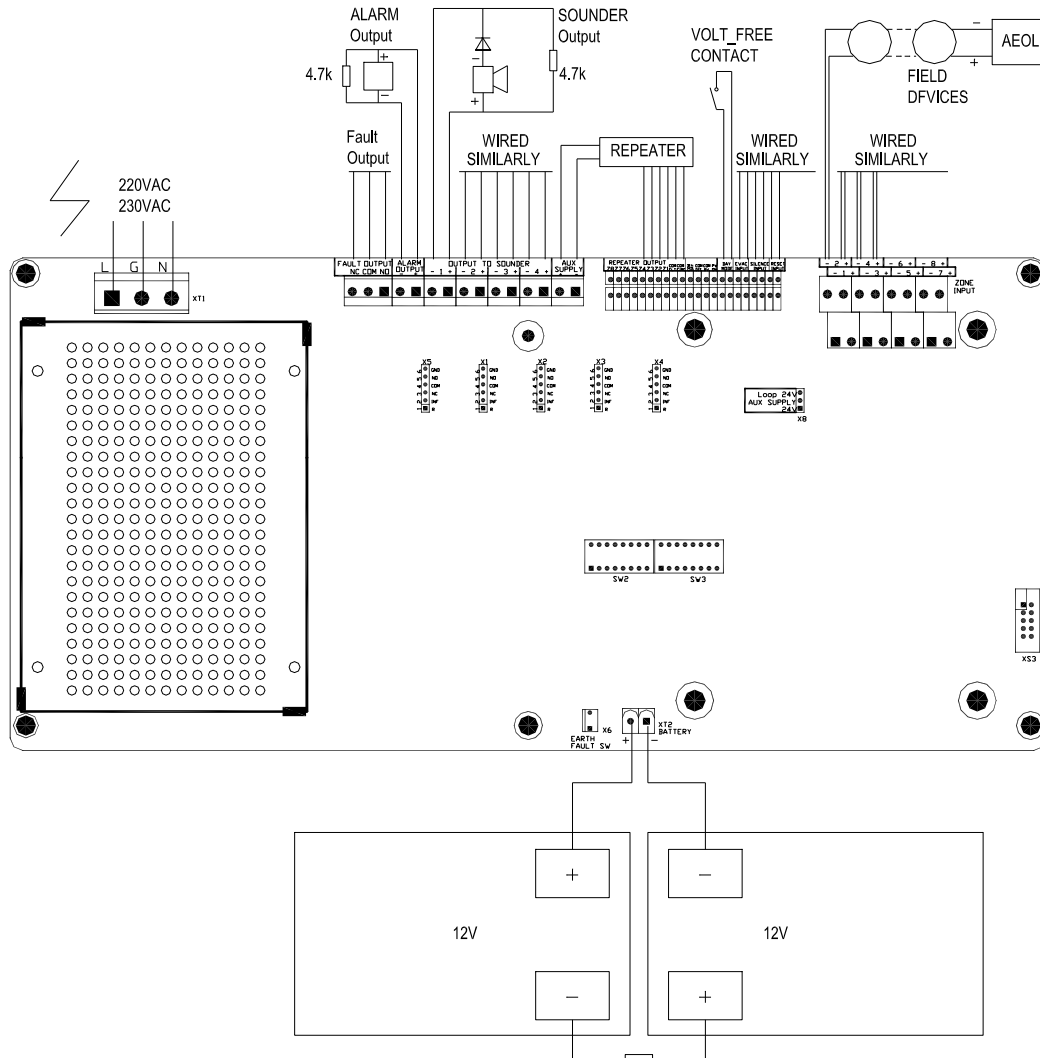

## Appendix 4 Wiring Diagram for GST102A FACP

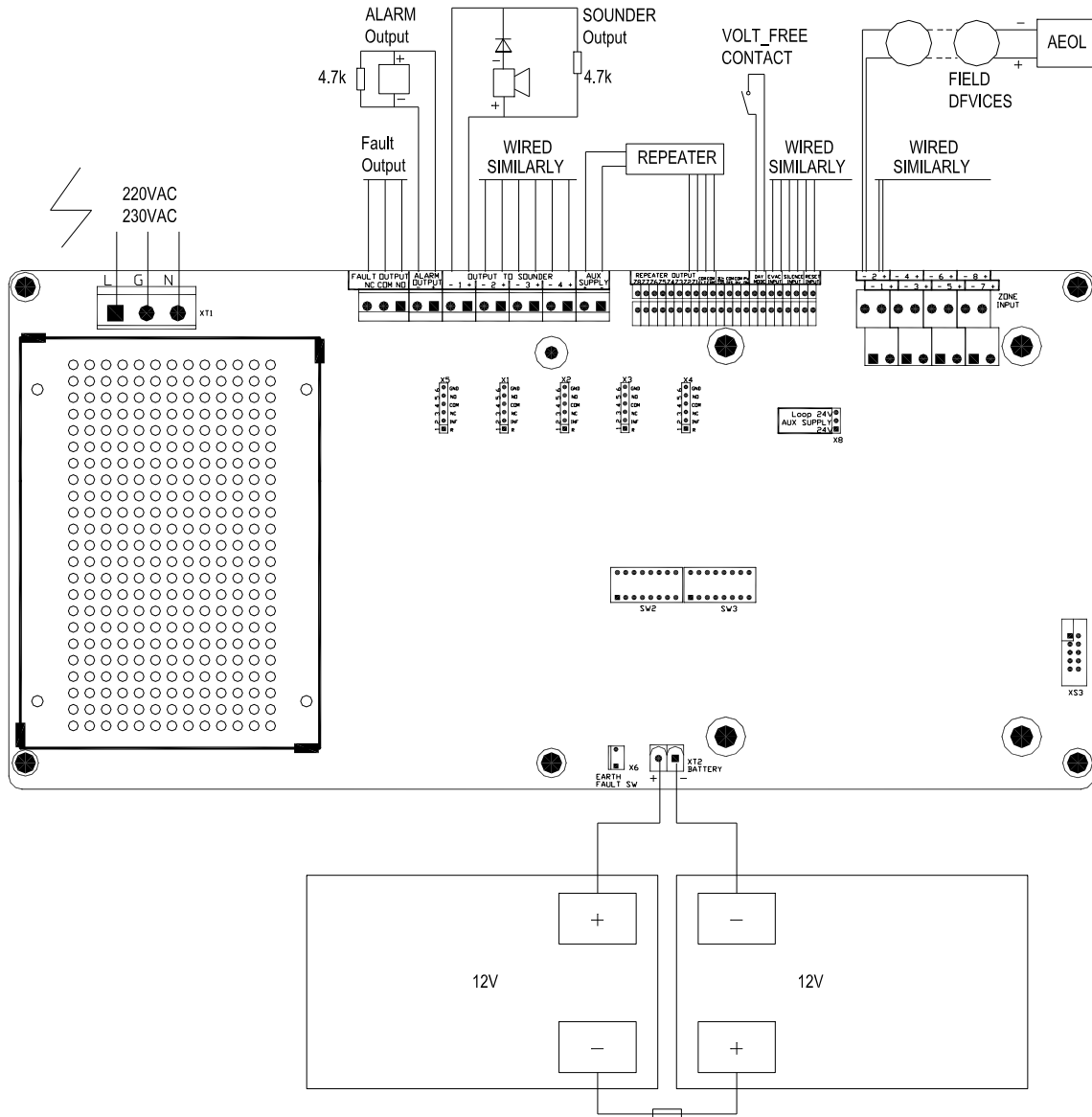

### Appendix 5 Appearance of GST116A FACP

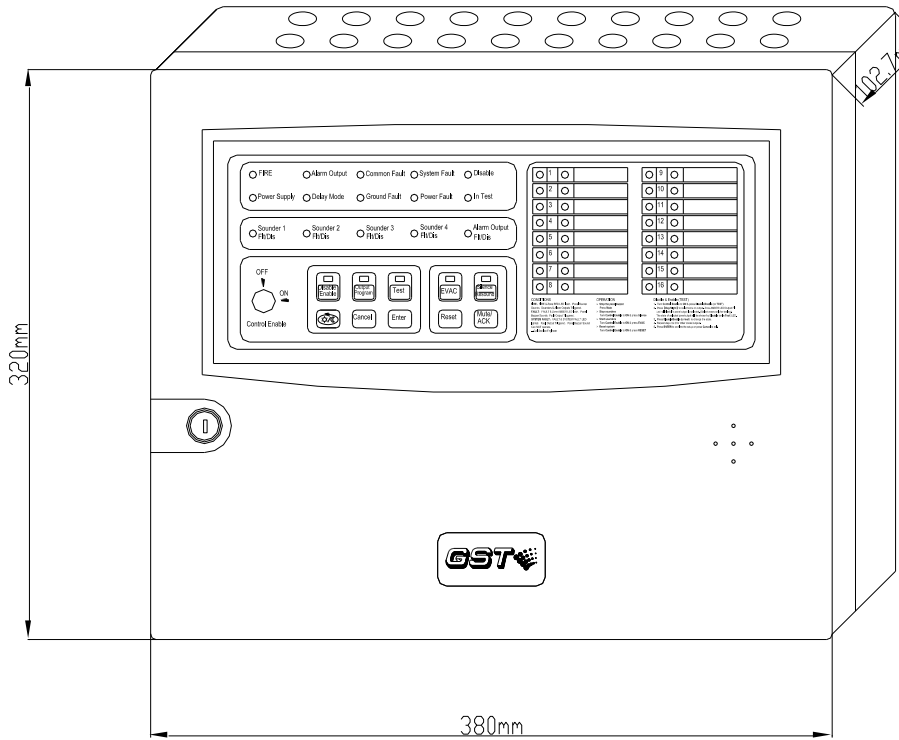

### Appendix 6 Appearance of GST108A FACP

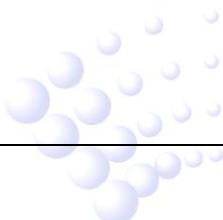
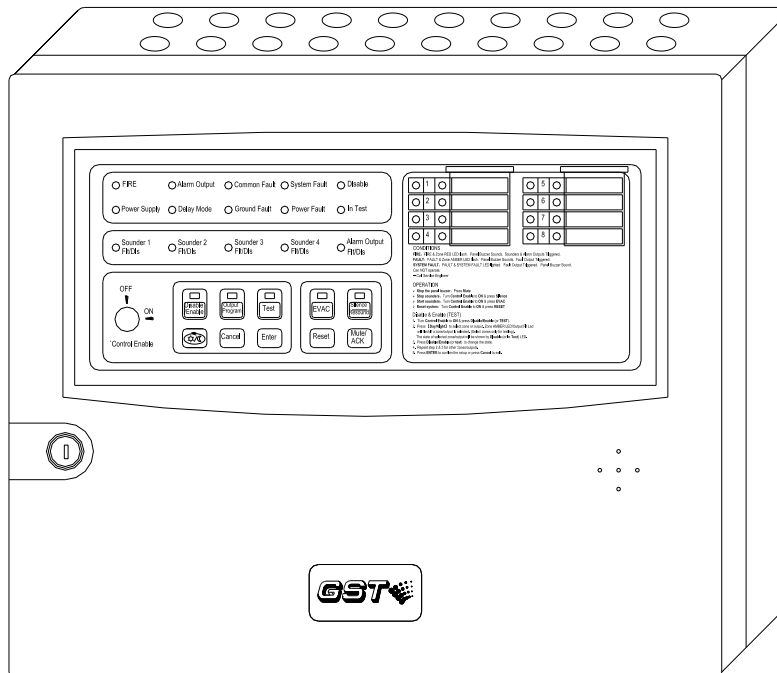

## Appendix 7 Appearance of GST104A FACP

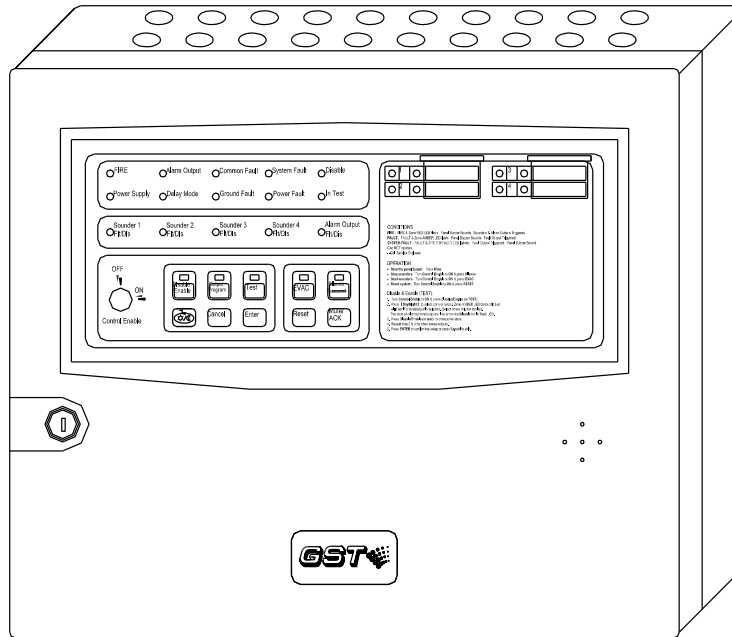

## Appendix 8 Appearance of GST102A FACP

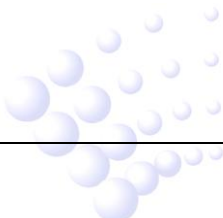
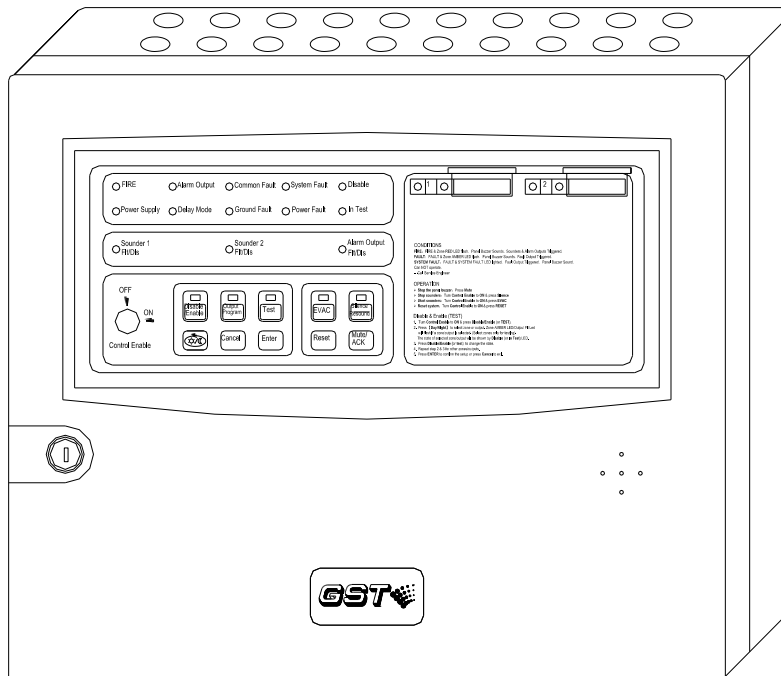



Gulf Security Technology Co., Ltd.

No. 80, Changjiang East Road, QETDZ, Qinhuangdao, Hebei,

P. R. China 066004

Tel: +86 (0) 335 8502434

Fax: +86 (0) 335 8502532

[service.gst@fs.utc.com](mailto:service.gst@fs.utc.com)

[www.gst.com.cn](http://www.gst.com.cn)